

Thank you very much for purchasing Panasonic products. Please read this Instruction Manual carefully and thoroughly for the correct and optimum use of this product. Kindly keep this manual in a convenient place for quick reference.



- Never use this product as a sensing device for personnel protection.
- In case of using sensing devices for personnel protection, use products which meet standards, such as OSHA, ANSI or IEC etc., for personnel protection applicable in each region or country.

## 1 SPECIFICATIONS

Type	Thru-beam		
Item	Cable length 2m	Cable length 3m	Cable length 5m
	<b>RX4-M5</b>	<b>RX4-M5-C3</b>	<b>RX4-M5-C5</b>
Sensing range	5m		
Sensing object	φ 10mm or more opaque object		
Repeatability	Perpendicular to sensing axis: 0.05mm or more		
Supply voltage	12 to 24V DC ± 10% Ripple P-P 10% or less		
Current consumption	Emitter: 20mA or less, Receiver: 25mA or less		
Sensing output	NPN open-collector transistor • Maximum sink current: 100mA • Applied voltage: 30V DC or less (between sensing output and 0V) • Residual voltage: 2V or less (at 100mA sink current) 1V or less (at 16mA sink current)		
Output operation	Switchable either Light-ON or Dark-ON		
Short-circuit protection	Incorporated		
Self-diagnosis output	NPN open-collector transistor • Maximum sink current: 50mA • Applied voltage: 30V DC or less (between self-diagnosis output and 0V) • Residual voltage: 1.5V or less (at 50mA sink current) 1V or less (at 16mA sink current)		
Output operation	ON under unstable sensing condition		
Short-circuit protection	—		
Response time	1ms or less		
Test input (emission halt) function	Incorporated		
Operation indicator	Red LED (lights up when the sensing output is ON)		
Stability indicator	Green LED (lights up under stable light received condition or stable dark condition)		
Emitting indicator	Red LED (lights up during beam emission)		
Sensitivity adjuster	Continuously variable adjuster		
Protection	IP67 (IEC), IP67g (JEM)		
Ambient temperature	-25 to +60°C (No dew condensation or icing allowed), Storage: -30 to +70°C		
Ambient humidity	35 to 85% RH, Storage: 35 to 85% RH		
Emitting element	Infrared LED (modulated)		
Material	Enclosure: Die-cast zinc alloy (Fluorine resin coating), Indicator cover: Polyethersulphone, Lens: Polyacrylate, Protective tube sheath: Oil resistant PVC		
Cable	0.15mm <sup>2</sup> 4-core (emitter: 3-core) oil, heat and cold resistant cable		
Protective tube length	1m	2m	4m
Weight	Emitter: 175g approx., Receiver: 175g approx.	Emitter: 265g approx., Receiver: 265g approx.	Emitter: 495g approx., Receiver: 495g approx.
Accessories	<b>MS-RX-2</b> (Sensor mounting bracket): 1 set for emitter and receiver, Adjusting screwdriver: 1 pc.		

Note: The model No. with suffix 'P' shown on the label affixed to the sensor is the emitter, 'D' shown on the label is the receiver.  
 Emitter: **RX4-M5P**, Receiver: **RX4-M5D**

## 2 CAUTIONS

- Make sure that the power supply is off while wiring.
- Take care that wrong wiring will damage the sensor.
- Verify that the supply voltage variation is within the rating.
- If power is supplied from a commercial switching regulator, ensure that the frame ground (F.G.) terminal of the power supply is connected to an actual ground.
- In case noise generating equipment (switching regulator, inverter motor, etc.) is used in the vicinity of this product, connect the frame ground (F.G.) terminal of the equipment to an actual ground.
- Do not run the wires together with high-voltage lines or power lines or put them in the same raceway. This can cause malfunction due to induction.
- Extension up to total 100m, is possible with 0.3mm<sup>2</sup>, or more, cable. However, in order to reduce noise, make the wiring as short as possible.
- Do not use during the initial transient time (50ms) after the power supply is switched on.

- Take care that the sensor is not directly exposed to fluorescent lamp from a rapid-starter lamp or a high frequency lighting device, as it may affect the sensing performance.
- The self-diagnosis output does not incorporate a short-circuit protection circuit. Do not connect it directly to a power supply or a capacitive load.
- When the self-diagnosis output or the test input is not used, make them to be in the open state by insulating them.
- After sensitivity adjustment is made, close the front panel completely and tighten the panel securing screw firmly so that the protective structure could be maintained.
- Avoid dust, dirt, and steam.
- Take care that the sensor does not come in direct contact with water, oil, grease, or organic solvents, such as, thinner etc.
- Make sure that stress by forcible bend or pulling is not applied directly to the sensor cable joint.

## 3 MOUNTING

- The tightening torque should be 1.17N·m or less.

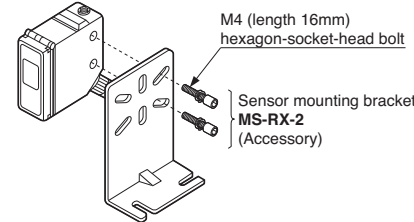

## 4 I/O CIRCUIT DIAGRAMS

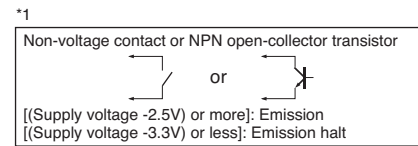
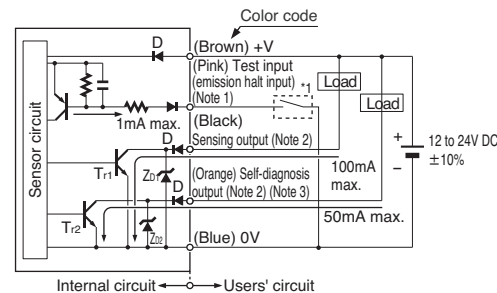

Symbols...: D: Reverse supply polarity protection diode  
 Z<sub>o1</sub>, Z<sub>o2</sub>: Surge absorption zener diode  
 T<sub>1</sub>, T<sub>2</sub>: NPN output transistor

- Notes:
- 1) The receiver of the thru-beam type sensor does not incorporate the test input (emission halt input).
  - 2) The emitter of the thru-beam type sensor does not incorporate the sensing output and the self-diagnosis output.
  - 3) The self-diagnosis output does not incorporate a short-circuit protection circuit. Do not connect it directly to a power supply or a capacitive load.

## 5 CONNECTION OF PROTECTIVE TUBE CONNECTOR

- Connect the junction connector securely as shown below. The tightening torque should be 0.98N·m or less.

### When mounting on a plate

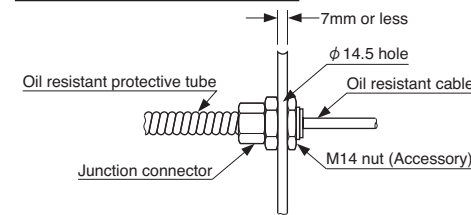

### When mounted with a female screw

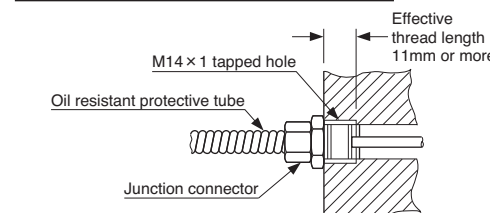

### When connected to another protective tube

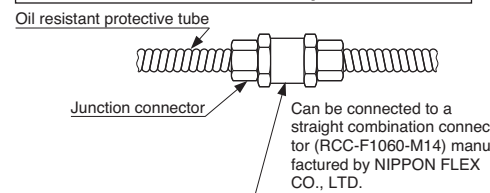

## 6 ADJUSTMENTS

### Part description

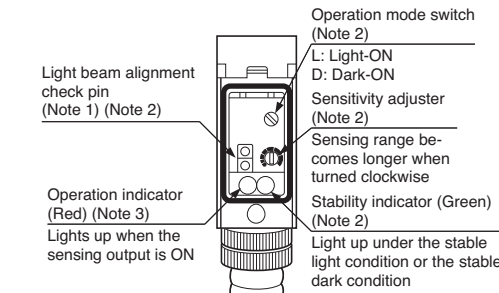

- Notes:
- 1) This is for the sensor checker **CHX-SC1**. Note that **CHX-SC1** has been with down since Feb. 2001.
  - 2) Not incorporated on the thru-beam type sensor emitter.
  - 3) It is the emission halt indicator (lights up when emission halts) for the thru-beam type sensor emitter.

### Sensitivity adjustment

Step	Sensitivity adjuster	Description
①	MIN. MAX.	Turn the sensitivity adjuster fully counter-clockwise to the minimum sensitivity position, Min.
②	MIN. MAX.	In the light received condition, turn the sensitivity adjuster slowly clockwise and confirm the point ㉔ where the sensor enters the 'Light' state operation.
③	MIN. MAX.	In the dark condition, turn the sensitivity adjuster further clockwise until the sensor enters the 'Light' state operation and then bring it back to confirm point ㉔ where the sensor just returns to the 'Dark' state operation. If the sensor does not enter the 'Light' state operation even when the sensitivity adjuster is turned fully clockwise, the position is point ㉕.
④	MIN. MAX.	The position at the middle of points ㉔ and ㉕ is the optimum sensing position.

Note: Use the accessory adjuster screwdriver to turn the adjuster slowly. Turning with excessive strength will cause damage to the adjuster.

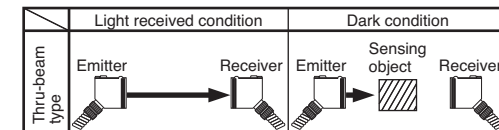

### Beam alignment

- ① Set the operation mode switch to the Light-ON mode position (MODE L side).
- ② Placing the emitter and the receiver face to face along a straight line, move the emitter in the up, down, left and right directions, in order to determine the range of the light received condition with the help of the operation indicator (red). Then, set the emitter at the center of this range.
- ③ Similarly, adjust for up, down, left and right angular movement of the emitter.
- ④ Further, perform the angular adjustment for the receiver also.
- ⑤ Check that the stability indicator (green) lights up.
- ⑥ Choose the operation mode, Light-ON or Dark-ON, as per your requirement, with the operation mode switch.

### Relation between sensing output and indicators

☆ : Lights up ● : Turns off

In case of Light-ON				In case of Dark-ON			
Stability indicator	Operation indicator	Sensing output	Sensing condition	Sensing output	Operation indicator	Stability indicator	
☆	☆	ON	Stable light receiving	OFF	●	☆	☆
●	☆	ON	Unstable light receiving	OFF	●	●	●
☆	●	OFF	Unstable dark receiving	ON	☆	☆	☆
☆	●	OFF	Stable dark receiving	ON	☆	☆	☆

## 7 TEST INPUT (EMISSION HALT INPUT)

- When the test input (emission halt input) is connected to 0V, the emission stops. This function can be used for operation check before start the operation, and also for synchronization input.

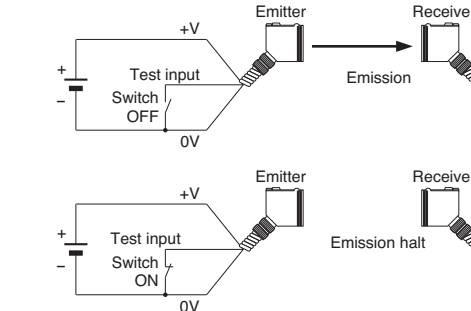

### Operation check

The emission is done intermittently for confirming that the output follows and checking the operation.

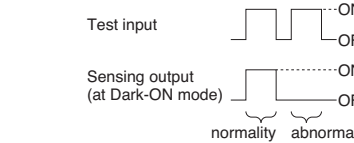

## 8 SELF-DIAGNOSIS

- The sensor diagnosis the incident light intensity, and if it is reduced due to dirt or dust, or beam misalignment an output is generated.

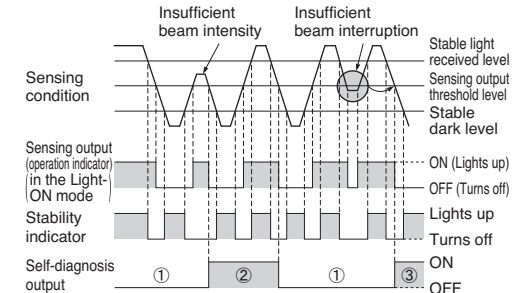

- ① The self-diagnosis output transistor stays in the 'OFF' state during stable sensing.
- ② When the sensing output changes, if the incident light intensity does not reach the stable light received level or the stable dark level, the self-diagnosis output becomes ON.
- ③ In case of insufficient beam interruption, there will be a time lag before the self-diagnosis output turns ON.